



DET10A2 **Si Biased Detector**

User Guide



















Table of Contents

Chapter 1	Warning Symbol Definitions	1
Chapter 2	Description	2
Chapter 3	Setup	3
Chapter 4	Operation	4
4.1.	<i>Theory of Operation</i>	4
4.2.	<i>Responsivity</i>	4
4.3.	<i>Modes of Operation</i>	4
4.4.	<i>Dark Current</i>	5
4.5.	<i>Junction Capacitance</i>	6
4.6.	<i>Bandwidth and Response</i>	6
4.7.	<i>Terminating Resistance</i>	7
4.8.	<i>Shunt Resistance</i>	7
4.9.	<i>Series Resistance</i>	7
4.10.	<i>Battery Check</i>	7
4.11.	<i>Battery Replacement</i>	8
Chapter 5	Common Operating Circuits	9
Chapter 6	Troubleshooting.....	11
Chapter 7	Specifications.....	12
7.1.	<i>Response Curve</i>	13
7.2.	<i>Mechanical Drawing</i>	14
Chapter 8	Certificate of Conformance.....	15
Chapter 9	Regulatory	16
Chapter 10	Thorlabs Worldwide Contacts	17

Chapter 1 Warning Symbol Definitions

Below is a list of warning symbols you may encounter in this manual or on your device.

Symbol	Description
	Direct Current
	Alternating Current
	Both Direct and Alternating Current
	Earth Ground Terminal
	Protective Conductor Terminal
	Frame or chassis Terminal
	Equipotentiality
	On (Supply)
	Off (Supply)
	In Position of a Bi-Stable Push Control
	Out Position of a Bi-Stable Push Control
	Caution, Risk of Electric Shock
	Caution, Hot Surface
	Caution, Risk of Danger
	Warning, Laser Radiation
	Caution: ESD Sensitive Components

Chapter 2 Description

The Thorlabs DET10A2 is a biased, Silicon (Si) detector designed for detection of light signals ranging from 200 nm to 1100 nm. The unit comes complete with a photodiode and an internal 12 V bias battery enclosed in a rugged aluminum housing. The DET10A2 includes a removable 1" optical coupler (SM1T1), providing easy mounting of ND filters, spectral filters, fiber adapters (SMA, FC and ST style), and other 1" stackable lens mount accessories offered by Thorlabs.



ESD Caution



The components inside this instrument are ESD sensitive. Take all appropriate precautions to discharge personnel and equipment before making any electrical connections to the unit.



Caution!



Long-term exposure to high-energy UV light may degrade the performance and specifications of this Si detector.

Chapter 3 Setup

The detector can be set up in many different ways using our extensive line of adapters. However, the detector should always be mounted and secured for best operation. Step 1 in the setup instructions below outline how to mount the detector onto a post.

1. Unpack the optical head, install either an imperial or metric optical post into one of the mounting holes located on the bottom and side of the sensor, and mount using a post holder. Note that these detectors feature tapped holes that accept both 8-32 and M4 threads, so using either imperial or metric TR posts is possible.
2. Attach a 50 Ω coax cable (i.e. RG-58U) to the output of the DET. Select and install a terminating resistor to the remaining end of the cable and connect to a voltage measurement device. See Chapter 4, page 7 to determine resistor values. Thorlabs sells a 50 Ω terminator (T4119) for best frequency performance and a variable terminator (VT2) for output voltage flexibility. Note the input impedance of your measurement device since this will act as a terminating resistor. A load resistor is not necessary when using current measurement devices.
3. Power the DET on using the power switch. To check battery voltage, see the Battery Check section on page 7.
4. Install any desired filters, optics, adapters, or fiber adapters to the input aperture.



Caution!



The DET10A2 was designed to allow maximum accessibility to the photodetector by having the active area surface of the diode flush with the outside of the DET housing. When using fiber adapters, make sure that the fiber ferrule does not crash into the detector. Failure to do so may cause damage to the diode and/or the fiber.

5. During alignment, take appropriate precautions, such as using reduced radiation power, or other precautions, and use proper eye and/or skin protection as recommended by the radiation source manufacturer.
6. Apply a light source to the detector.

Chapter 4 Operation

4.1. Theory of Operation

A junction photodiode is an intrinsic device which behaves similarly to an ordinary signal diode, but it generates a photocurrent when light is absorbed in the depleted region of the junction semiconductor. A photodiode is a fast, highly linear device that exhibits high quantum efficiency based upon the application and may be used in a variety of different applications.

It is necessary to be able to correctly determine the level of the output current to expect and the responsivity based upon the incident light. Depicted in Figure 1 is a junction photodiode model with basic discrete components to help visualize the main characteristics and gain a better understanding of the operation of Thorlabs' photodiodes.

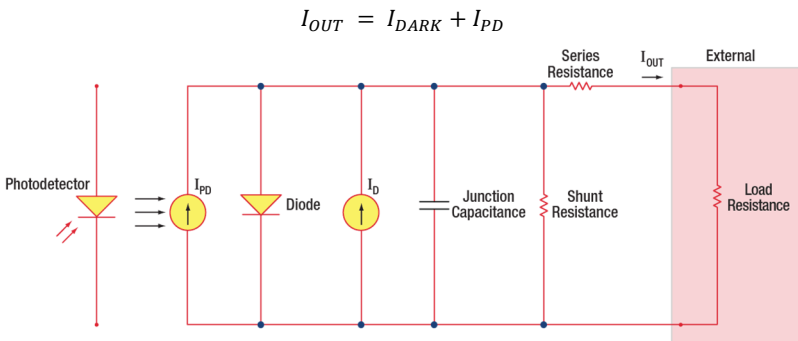

Figure 1 Photodiode Model

4.2. Responsivity

The responsivity of a photodiode can be defined as a ratio of generated photocurrent (I_{PD}) to the incident light power (P) at a given wavelength:

$$R(\lambda) = \frac{I_{PD}}{P}$$

4.3. Modes of Operation

A photodiode can be operated in one of two modes: photoconductive (reverse bias) or photovoltaic (zero-bias). Mode selection depends upon the applications speed requirements and the amount of tolerable dark current (leakage current).

Photoconductive

In photoconductive mode, an external reverse bias is applied, which is the basis for our DET series detectors. The current measured through the circuit indicates illumination of the device; the measured output current is linearly proportional to the input optical power. Applying a reverse bias increases the width of the depletion junction producing an increased responsivity with a decrease in junction capacitance and produces a very linear response. Operating under these conditions does tend to produce a larger dark current but this can be limited based upon the photodiode material.

Note

The DET detectors are reverse biased and cannot be operated under forward bias conditions.

Photovoltaic

In photovoltaic mode the photodiode is zero biased. The flow of current out of the device is restricted and a voltage builds up. This mode of operation exploits the photovoltaic effect which is the basis for solar cells.

4.4. Dark Current

Dark current is leakage current which flows when a bias voltage is applied to a photodiode. Photoconductive mode tends to generate a dark current that varies directly with temperature. It can be inferred that dark current can approximately double for every 10 °C increase in temperature, and shunt resistance can decrease to approximately half for every 6 °C rise. Of course, applying a higher bias will decrease the junction capacitance but will increase the amount of dark current present.

The dark current present is also affected by the photodiode material and the size of the active area. Silicon devices generally produce low dark current compared to germanium devices which have high dark currents. The table below lists several photodiode materials and their relative dark currents, speeds, sensitivity, and costs. The table below gives some advantages to each common type of detector material. Please note that sensitivity values in the table are typical values; Thorlabs offers photodetectors with sensitivity ranges that vary from those shown below.

Material	Dark Current	Speed	Sensitivity ¹ (nm)	Cost
Silicon (Si)	Low	High	400 – 1000	Low
Germanium (Ge)	High	Low	900 – 1600	Low
Gallium Phosphide (GaP)	Low	High	150 – 550	Med
Indium Gallium Arsenide (InGaAs)	Low	High	800 – 1800	Med
Extended Range: Indium Gallium Arsenide (InGaAs)	High	High	1200 – 2600	High

4.5. Junction Capacitance

Junction capacitance (C_J) is an important property of a photodiode as this can have a profound impact on the bandwidth and the response of a photodiode. It should be noted that larger diode areas encompass a greater junction volume with increased charge capacity. In a reverse bias application, the depletion width of the junction is increased, thus effectively reducing the junction capacitance and increasing the response speed.

4.6. Bandwidth and Response

The response time of a photodiode is a function the speed at which these charges move inside the semiconductor as well as the external circuitry connected to the photodiode. The three main contributions to the response time are drift time, diffusion, and rise time of the RC circuit.

Drift time (t_{dr}): Time for electron-hole pairs to move from the depletion zone to the electrodes. The depletion zone has an intrinsic electric field that accelerates the charges so that they are collected quickly. Hence, the drift time is generally in the ps time regime.

Diffusion (t_{diff}): Diffusion time for electron-hole pairs generated outside of the depletion zone to be collected. Depending on the wavelength used, a larger proportion of electron-hole pairs are generated in the N and P layers of the semiconductor, which do not have an electric field to accelerate the charges. Therefore, the charges are only collected after slowly diffusing through the semiconductor.

RC (t_{RC}): Rise time of the RC circuit formed by the junction capacitance of the photodiode, its series resistance (generally negligible), and the load resistance. This is generally the dominating factor on the bandwidth of the PDs and detectors and is the reason why the bandwidth is specified for a particular load resistance. For best frequency response, a 50 Ω terminator should be used in conjunction with a 50 Ω coaxial cable. The bandwidth (f_{BW}) and the rise time response (t_r) can be approximated using the junction capacitance and the load resistance (R_{LOAD}):

¹ Approximate values, actual wavelength values will vary.

$$f_{BW} = \frac{1}{(2\pi R_{LOAD} \times C_j)}$$
$$t_r = \frac{0.35}{f_{BW}}$$

4.7. Terminating Resistance

A load resistance is used to convert the generated photocurrent into a voltage (V_{OUT}) for viewing on a voltage reading device, e.g., an oscilloscope.

$$V_{OUT} = I_{OUT} \times R_{LOAD}$$

Depending on the type of the photodiode, load resistance can affect the response speed. For maximum bandwidth, we recommend using a 50 Ω coaxial cable with a 50 Ω terminating resistor at the opposite end of the cable. This will minimize ringing by matching the cable with its characteristic impedance. If bandwidth is not important, you may increase the amount of voltage for a given light level by increasing R_{LOAD} . In an unmatched termination the length of the coaxial cable can have a profound impact on the response, so it is recommended to keep the cable as short as possible.

4.8. Shunt Resistance

Shunt resistance represents the resistance of the zero-biased photodiode junction. An ideal photodiode will have an infinite shunt resistance, but actual values may range from the order of ten Ω to thousands of $M\Omega$ and is dependent on the photodiode material. For example, an InGaAs detector has a shunt resistance on the order of 10 $M\Omega$ while a Ge detector is in the $k\Omega$ range. This can significantly impact the noise current on the photodiode. For most applications, however, the high resistance produces little effect and can be ignored.

4.9. Series Resistance

Series resistance models the resistance of the semiconductor material plus the contacts and the wire bonds, and this low resistance can generally be ignored. The series resistance is used to determine the linearity of the photodiode under zero bias conditions.

4.10. Battery Check

The DET series includes a battery check feature that will allow the user to monitor the bias voltage on the output BNC. Simply hold down the "Battery Check" button located on the bottom edge of the unit. The bias voltage will be output to the BNC. If a high impedance load is used (>100 $k\Omega$), the output will be equal to the bias voltage. This feature includes a 2.49 $k\Omega$ current limiting resistor (RCL) to prevent excessive loading of the battery if using small terminating resistors. For example, a 50 Ω load resistor with a 10 V bias will produce a

200 mA current without this resistor. This will significantly decrease lifetime of the battery.

The output bias voltage will be dependent on the load resistor as described below. The A23 battery voltage characteristics show that the charge level is almost depleted as the voltage drops below 10 V. For this calculation we assume 9.6 V since $V_{BAT} = \text{low battery voltage} - \text{one diode drop (0.6 V)} = \sim 9 \text{ V}$. The detector will continue to operate until the battery charge is completely drained, however these numbers provide a reference point at which the battery should be replaced.

$$V_{OUT} = V_{BAT} * \left[\frac{R_{LOAD}}{R_{LOAD} + R_{CL}} \right]$$

$$\text{Example: } V_{BAT} = 9 \text{ V}, R_{LOAD} = 50 \Omega, R_{CL} = 2540 \Omega$$

$$V_{out} = 170 \text{ mV}$$

Note that V_{out} is a theoretical value. If one would like to reverse calculate the bias voltage more precisely using this feature, then a high impedance load is suggested.

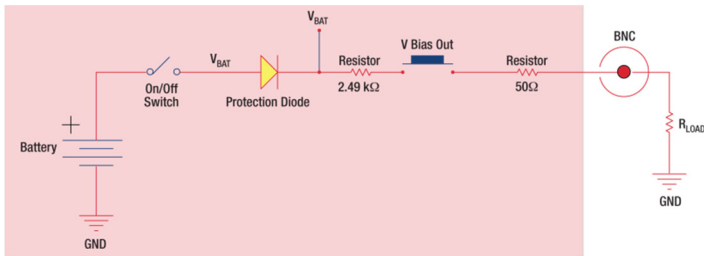

4.11. Battery Replacement

Thorlabs delivers each DET with an A23 12 V battery. This battery is readily available at most retail stores, as well as through Thorlabs. The battery supplied will deliver about 40 hours with a 1 mA load, roughly equivalent to a continuous 1.5 mW light source with responsivity 0.6 A/W. The supply current when the unit is on and no light is applied is very small and should not significantly degrade the battery.

Locate the battery cap directly above the output BNC. Unthread the cap and remove the battery. Install the new battery into the cap, negative side in, and thread back into the DET. Be careful not to cross thread the cap into the housing. The DET includes a protection diode to prevent damage if the battery is installed backwards. The battery direction is located on the housing.



Chapter 5 Common Operating Circuits

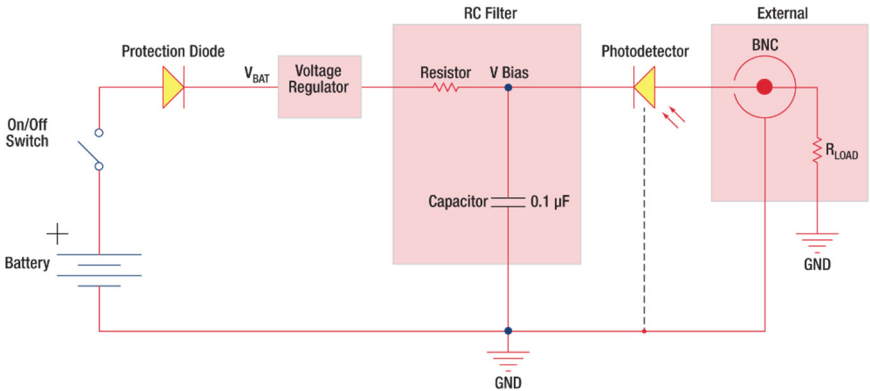

Figure 2 Basic DET Circuit

The DET Series Detectors are designed according to the circuit depicted above. The detector is reverse biased to produce a linear response with applied input light. The photocurrent generated is based upon the incident light and wavelength and can be viewed on the oscilloscope by attaching a load resistance on the output. The function of the RC Filter is to filter any high frequency noise from the input supply which may contribute to a noisy output.

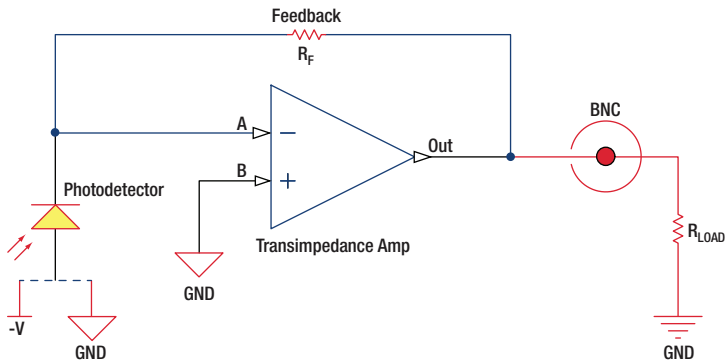

Figure 3 Amplified Detector

One can also use a photodetector with an amplifier for the purpose of achieving high gain. The user can choose whether to operate in Photovoltaic or Photoconductive modes. There are a few benefits of choosing this active circuit:

- Photovoltaic Mode: The circuit is held at zero volts across the photodiode, since point A is held at the same potential as point B by the operational amplifier. This eliminates the possibility of dark current.
- Photoconductive mode: The photodiode is reversed biased, thus improving the bandwidth while lowering the junction capacitance. The gain of the detector is dependent on the feedback element (R_F). The bandwidth of the detector can be calculated using the following:

$$f(-3dB) = \sqrt{\frac{GBP}{4\pi R_f \times C_D}},$$

where GBP is the amplifier gain bandwidth product and C_D is the sum of the junction capacitance, amplifier capacitance, and feedback capacitance.

Chapter 6 Troubleshooting

Problem	Suggested Solutions
<p>There is no signal response.</p>	<p>Verify that the power is switched on and all connections are secure.</p>
	<p>Verify the proper terminating resistor is installed if using a Voltage measurement device.</p>
	<p>Verify that the optical signal wavelength is within the specified wavelength range.</p>
	<p>Verify that the optical signal is illuminating the detector active area.</p>
	<p>Connect the DET to an oscilloscope without a terminating resistor installed. Most general purpose oscilloscopes will have a 1 MΩ input impedance. For visible detectors, point the detector toward a fluorescent light and verify that a 60 Hz (50 Hz outside the US) signal appears on the scope. If so the device should be operating properly and the problem may be with the light source or alignment.</p>
<p>There is an AC signal present when the unit is turned off.</p>	<p>The detector has an AC path to ground even with the switch in the OFF position. It is normal to see an output response to an AC signal with the switch in this state. However, because the detector is unbiased, operation in this mode is not recommended.</p>
<p>The output appears AC coupled with long rise times and the power switch ON.</p>	<p>This is usually an indication that the battery level is low and needs to be changed. See the Battery Check and Replacement Section.</p>

Chapter 7 Specifications

All measurements are performed at 25 °C ambient temperature unless stated otherwise.

Electrical Specifications		
Detector	-	Si
Active Area	-	Ø1.0 mm (0.8 mm ²)
Wavelength Range ²	λ	200 to 1100 nm
Peak Wavelength	λ_p	730 nm (Typ.)
Peak Response ³	$\Re(\lambda_p)$	0.44 A/W (Typ.)
Junction Capacitance	C_J	6 pF (Typ.)
Rise Time ^{3,4,5}	t_r	1 ns (Typ.)
NEP (λ_p)	-	5.0×10^{-14} W/ $\sqrt{\text{Hz}}$ (Typ.)
Bias Voltage	V_R	10 V
Dark Current ⁶	I_D	0.3 nA (Typ.) 2.5 nA (Max)
Output Current	I_{OUT}	0 to 10 mA
General		
On/Off Switch	Slide	
Battery Check Switch	Momentary Pushbutton	
Output	BNC (DC Coupled)	
Package Size	2.79" x 1.96" x 0.89" (70.9 mm x 49.8 mm x 22.5 mm)	
PD Surface Depth ⁷	0.09" (2.2 mm)	
Weight	0.10 kg	
Accessories	SM1T1 Coupler SM1RR Retainer Ring	
Storage Temp	-20 to 70 °C	
Operating Temp	10 to 50 °C	
Battery	A23, 12 V _{DC} , 40 mAh	
Low Battery Voltage ⁸	(See Battery Check)	
V _{OUT} (Hi-Z)	~9 V	
V _{OUT} (50 Ω)	~170 mV	

² When long-term UV light is applied, the product specifications may degrade. For example, the product's UV response may decrease and the dark current may increase. The degree to which the specifications may degrade is based upon factors such as the irradiation level, intensity, and usage time.

³ Measured with specified bias voltage of 10.0 V.

⁴ Low battery voltage will result in slower rise times and decreased bandwidth.

⁵ For a 50 Ω Load

⁶ Measured with a 1 M Ω Load

⁷ Measured from the active area to the start of the threads on the housing body. The detector active area surface is flush with the front of the housing body.

⁸ Assumes the battery voltage drops below 9.6 V. The reverse protection diode generates a 0.6 V drop.

7.1. Response Curve

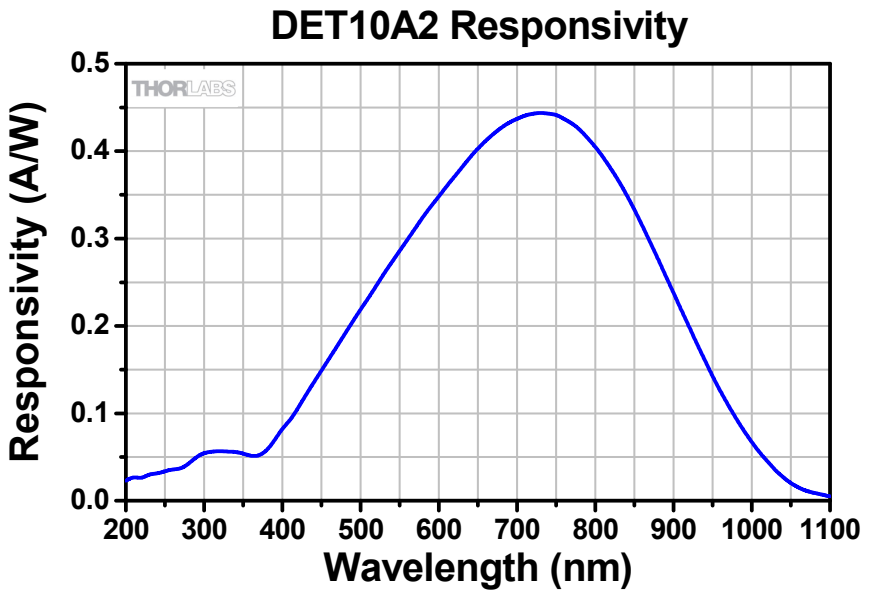

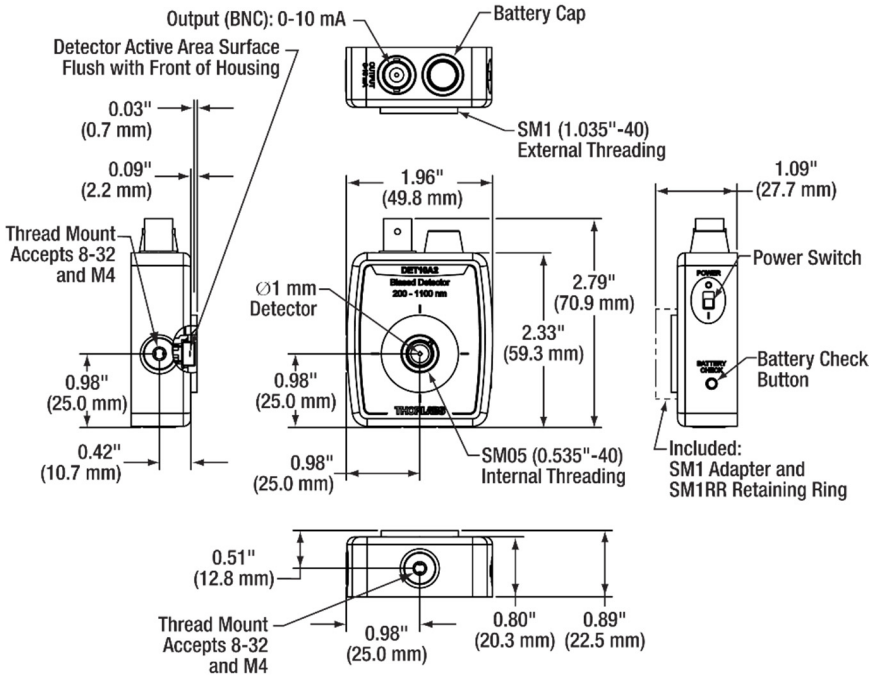

7.2. Mechanical Drawing

Visit the web for a more detailed mechanical drawing.



Chapter 8 Certificate of Conformance

		<h1>THORLABS</h1>	
		www.thorlabs.com	
<h3>EU Declaration of Conformity</h3> <p><i>in accordance with EN ISO 17050-1:2010</i></p>			
We:	Thorlabs Inc.		
Of:	56 Sparta Avenue, Newton, New Jersey, 07860, USA		
in accordance with the following Directive(s):			
2014/35/EU	Low Voltage Directive (LVD)		
2014/30/EU	Electromagnetic Compatibility (EMC) Directive		
2011/65/EU	Restriction of Use of Certain Hazardous Substances (RoHS)		
hereby declare that:			
Model:	DET05D2, DET100A2, DET10A2, DET10C2, DET10D2, DET10N2, DET20C2, DET25K2, DET30B2, DET36A2, DET50B2		
Equipment:	High-Speed Photodetectors		
is in conformity with the applicable requirements of the following documents:			
EN 61010-1	Safety Requirements for Electrical Equipment for Measurement, Control and Laboratory Use.		2010
EN 61326-1	Electrical Equipment for Measurement, Control and Laboratory Use - EMC Requirements		2013
and which, issued under the sole responsibility of Thorlabs, is in conformity with Directive 2011/65/EU of the European Parliament and of the Council of 8th June 2011 on the restriction of the use of certain hazardous substances in electrical and electronic equipment, for the reason stated below:			
does not contain substances in excess of the maximum concentration values tolerated by weight in homogenous materials as listed in Annex II of the Directive			
I hereby declare that the equipment named has been designed to comply with the relevant sections of the above referenced specifications, and complies with all applicable Essential Requirements of the Directives.			
Signed:		On:	09 January 2018
Name:	Ann Strachan		
Position:	Compliance Manager	EDC - DET05 D2, DET100A2, DET10A 2, DET...	
			

Chapter 9 Regulatory

As required by the WEEE (Waste Electrical and Electronic Equipment Directive) of the European Community and the corresponding national laws, Thorlabs offers all end users in the EC the possibility to return “end of life” units without incurring disposal charges.

- This offer is valid for Thorlabs electrical and electronic equipment:
- Sold after August 13, 2005
- Marked correspondingly with the crossed out “wheelie bin” logo (see right)
- Sold to a company or institute within the EC
- Currently owned by a company or institute within the EC
- Still complete, not disassembled and not contaminated



Wheelie Bin Logo

As the WEEE directive applies to self contained operational electrical and electronic products, this end of life take back service does not refer to other Thorlabs products, such as:

- Pure OEM products, that means assemblies to be built into a unit by the user (e.g. OEM laser driver cards)
- Components
- Mechanics and optics
- Left over parts of units disassembled by the user (PCB's, housings etc.).

If you wish to return a Thorlabs unit for waste recovery, please contact Thorlabs or your nearest dealer for further information.

Waste Treatment is Your Own Responsibility

If you do not return an “end of life” unit to Thorlabs, you must hand it to a company specialized in waste recovery. Do not dispose of the unit in a litter bin or at a public waste disposal site.

Ecological Background

It is well known that WEEE pollutes the environment by releasing toxic products during decomposition. The aim of the European RoHS directive is to reduce the content of toxic substances in electronic products in the future.

The intent of the WEEE directive is to enforce the recycling of WEEE. A controlled recycling of end of life products will thereby avoid negative impacts on the environment.

Chapter 10 Thorlabs Worldwide Contacts

For technical support or sales inquiries, please visit us at www.thorlabs.com/contact for our most up-to-date contact information.



USA, Canada, and South America

Thorlabs, Inc.
sales@thorlabs.com
techsupport@thorlabs.com

UK and Ireland

Thorlabs Ltd.
sales.uk@thorlabs.com
techsupport.uk@thorlabs.com

Europe

Thorlabs GmbH
europe@thorlabs.com

Scandinavia

Thorlabs Sweden AB
scandinavia@thorlabs.com

France

Thorlabs SAS
sales.fr@thorlabs.com

Brazil

Thorlabs Vendas de Fotônicos Ltda.
brasil@thorlabs.com

Japan

Thorlabs Japan, Inc.
sales@thorlabs.jp

China

Thorlabs China
chinasales@thorlabs.com



THORLABS

www.thorlabs.com
