



PDA10CS(-EC) InGaAs Switchable Gain Detector

User Guide



















Table of Contents

Chapter 1	Warning Symbol Definitions	1
Chapter 2	Description.....	2
Chapter 3	Setup.....	3
Chapter 4	Operation.....	4
	4.1. Theory of Operation.....	4
	4.2. Responsivity	4
	4.3. Dark Current	4
	4.4. Bandwidth and Response.....	5
	4.5. Terminating Resistance.....	5
	4.6. Gain Adjustment.....	6
Chapter 5	Troubleshooting	6
Chapter 6	Specifications	7
	6.1. Response Curve.....	9
	6.2. Mechanical Drawing.....	10
Chapter 7	Certificate of Conformance	11
Chapter 8	Regulatory.....	12
	8.1. Waste Treatment is Your Own Responsibility... 	12
	8.2. Ecological Background.....	12
Chapter 9	Thorlabs Worldwide Contacts.....	13

Chapter 1 Warning Symbol Definitions

Below is a list of warning symbols you may encounter in this manual or on your device.

Symbol	Description
	Direct Current
	Alternating Current
	Both Direct and Alternating Current
	Earth Ground Terminal
	Protective Conductor Terminal
	Frame or chassis Terminal
	Equipotentiality
	On (Supply)
	Off (Supply)
	In Position of a Bi-Stable Push Control
	Out Position of a Bi-Stable Push Control
	Caution, Risk of Electric Shock
	Caution, Hot Surface
	Caution, Risk of Danger
	Warning, Laser Radiation
	Caution, Spinning Blades May Cause Harm

Chapter 2 Description

The PDA10CS(-EC) is an amplified, switchable-gain, Indium Gallium Arsenide (InGaAs) detector designed for detection of light signals ranging from 900 to 1700 nm. An eight-position rotary switch allows the user to vary the gain in 10 dB steps. A buffered output drives 50 Ω load impedances up to 5 V. The PDA10CS(-EC) housing includes a removable threaded coupler (SM1T1) and retainer ring (SM1RR) that is compatible with any number of Thorlabs 1" threaded accessories. This allows convenient mounting of external optics, light filters, apertures, as well as providing an easy mounting mechanism using Thorlabs' cage assembly accessories.



ESD Caution



The components inside this instrument are ESD sensitive. Take all appropriate precautions to discharge personnel and equipment before making any electrical connections to the unit.

Chapter 3 Setup

The detector can be set up in many different ways using our extensive line of adapters. However, the detector should always be mounted and secured for best operation.

1. Unpack the optical head, install a Thorlabs TR-series 1/2" diameter post into one of the #8-32 (M4 on -EC version) tapped holes, located on the bottom and side of the head, and mount into a PH-series post holder.
2. Connect the power supply 3-pin plug into the power receptacle on the PDA10CS(-EC).
3. Plug the power supply into a 50 to 60 Hz, 100 to 120 VAC outlet (220 to 240 VAC for -EC version).
4. Attach a 50 Ω coax cable (i.e. RG-58U) to the output of the PDA. When running cable lengths longer than 12" we recommend terminating the opposite end of the coax with a 50 Ω resistor (Thorlabs p/n T4119) for maximum performance. Connect the remaining end to a measurement device such as an oscilloscope or high speed DAQ card. Caution: Many high speed oscilloscopes have input impedances of 50 Ω . In this case, do not install a 50 Ω terminator. The combined loads will equal 25 Ω which could allow ~135 mA of output current. This will damage the output driver of the PDA10CS(-EC).
5. Power the PDA10CS(-EC) on using the power switch located on the top side of the unit.



Caution!



The PDA10CS(-EC) was designed to allow maximum accessibility to the photodetector by having the front surface of the diode flush with the outside of the PDA housing. When using fiber adapters, make sure that the fiber ferrule does not crash into the detector. Failure to do so may cause damage to the diode and or the fiber. An easy way to accomplish this is to install a SM1RR retaining ring [included with the PDA10CS(-EC)] inside the 1" threaded coupler before installing the fiber adapter

6. Install any desired filters, optics, adapters, or fiber adapters to the input aperture.
7. During alignment, take appropriate precautions, such as using reduced radiation power, or other precautions, and use proper eye and/or skin protection as recommended by the radiation source manufacturer.
8. Apply a light source to the detector. Adjust the gain to the desired setting.

Chapter 4 Operation

4.1. Theory of Operation

Thorlabs PDA series are ideal for measuring both pulsed and CW light sources. The PDA10CS(-EC) includes a reverse-biased PIN photo diode, mated to a switchable gain transimpedance amplifier, and packaged in a rugged housing.

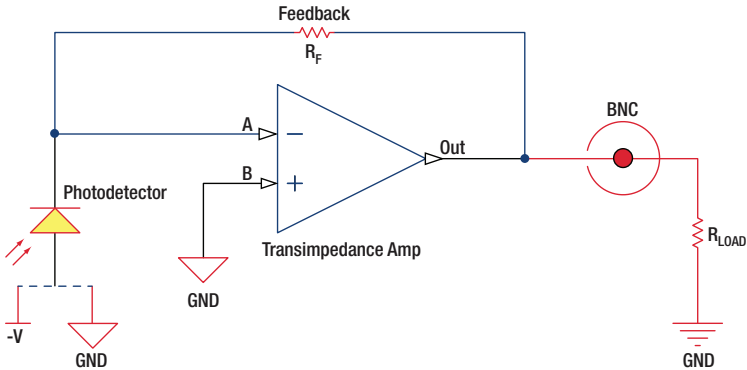

4.2. Responsivity

The responsivity of a photodiode can be defined as a ratio of generated photocurrent (I_{PD}) to the incident light power (P) at a given wavelength:

$$R(\lambda) = \frac{I_{PD}}{P}$$

4.3. Dark Current

Dark current is leakage current which flows when a bias voltage is applied to a photodiode. The PDA with Transimpedance Amplifier does control the dark current flowing out. Looking at the figure above, it can be noted that Point B is held at ground and the amplifier will try to hold point A to “Virtual Ground”. This minimizes the effects of dark current present in the system.

The dark current present is also affected by the photodiode material and the size of the active area. Silicon devices generally produce low dark current compared to germanium devices which have high dark currents. The table below lists several photodiode materials and their relative dark currents, speeds, sensitivity, and costs.

Material	Dark Current	Speed	Sensitivity ¹ (nm)	Cost
Silicon (Si)	Low	High	400 – 1000	Low
Germanium (Ge)	High	Low	900 – 1600	Low
Gallium Phosphide (GaP)	Low	High	150 – 550	Med
Indium Gallium Arsenide (InGaAs)	Low	High	800 – 1800	Med
Extended Range: Indium Gallium Arsenide (InGaAs)	High	High	1200 – 2600	High

4.4. Bandwidth and Response

A load resistor will react with the photodetector junction capacitance to limit the bandwidth. For best frequency response, a 50 Ω terminator should be used in conjunction with a 50 Ω coaxial cable. The gain of the detector is dependent on the feedback element (R_F). The bandwidth of the detector can be calculated using the following:

$$f(-3dB) = \sqrt{\frac{GBP}{4\pi R_f \times C_D}}$$

Where GBP is the amplifier gain bandwidth product and C_D is the sum of the photodiode junction capacitance and the amplifier capacitance.

4.5. Terminating Resistance

A load resistance is used to convert the generated photocurrent into a voltage (V_{OUT}) for viewing on an oscilloscope:

Depending on the type of the photodiode, load resistance can affect the response speed. For maximum bandwidth, we recommend using a 50 Ω coaxial cable with a 50 Ω terminating resistor at the opposite end of the cable. This will minimize ringing by matching the cable with its characteristic impedance. If bandwidth is not important, you may increase the amount of voltage for a given light level by increasing R_{LOAD} . In an unmatched termination the length of the coaxial cable can have a profound impact on the response, so it is recommended to keep the cable as short as possible.

The maximum output of the PDA10CS(-EC) is 10 volts for high impedance loads (i.e. $R_{LOAD} > 5 \text{ k}\Omega$) and 5 volts for 50 Ω loads. Adjust the gain so that the measured signal level out of the PDA10CS(-EC) is below 10 volts (5 volts with a 50 Ω load) to avoid saturation.

For low terminating resistors, <5 kΩ or 1% error, an additional factor needs to be considered. As described above the output includes a 50Ω series resistor (R_S). The output load creates a voltage divider with the 50Ω series resistor as follows:

¹ Approximate values, actual wavelength values will vary from unit to unit

$$\text{Scale Factor} = \frac{R_{Load}}{R_{Load} + R_s}$$

$$V_{OUT} = \mathcal{R}(\lambda) * \text{Transimpedance Gain} * \text{Scale Factor} * \text{Input Power (W)}$$

4.6. Gain Adjustment

The PDA10CS(-EC) includes a low noise, low offset, high gain transimpedance amplifier that allows gain adjustment over a 70dB range. The gain is adjusted by rotating the gain control knob, located on the top side of the unit. There are 8 gain positions incremented in 10dB steps. It is important to note that the bandwidth will decrease as the gain increases. See the specifications table in **Chapter 6** to choose the best gain vs. bandwidth for a given input signal.

Chapter 5 Troubleshooting

Problem	Suggested Solutions
There is no signal response.	Verify that the power is switched on and all connections are secure.
	Verify the proper terminating resistor is installed if using a Voltage measurement device.
	Verify that the optical signal wavelength is within the specified wavelength range.
	Verify that the optical signal is illuminating the detector active area.
Output Voltage will not increase. Detector Output is skewed.	Check to make sure the detector is not saturated. Refer to the Output Voltage spec. in the Specifications table. Install a 1" Lens Tube (SM1L10) to the thread coupler (SM1T1) to baffle any external light sources to see if this improves the response.

Chapter 6 Specifications

All performance specifications are typical, performed at 25 °C ambient temperature, and assume a 50 Ω load, unless stated otherwise.

Performance Specifications ²			
0 dB Setting		40 dB Setting	
Gain (Hi-Z)	1.51 x 10 ³ V/A ±2%	Gain (Hi-Z)	1.51 x 10 ⁵ V/A ±2%
Gain (50 Ω)	0.75 x 10 ³ V/A ±2%	Gain (50 Ω)	0.75 x 10 ⁵ V/A ±2%
Bandwidth	17 MHz	Bandwidth	320 kHz
Noise (RMS)	600 μV	Noise (RMS)	300 μV
NEP (@ λ _p)	6.0 x 10 ⁻¹¹ W/√Hz	NEP (@ λ _p)	1.4 x 10 ⁻¹² W/√Hz
Offset	±5 mV (±10 mV max)	Offset	±10 mV (±20 mV max)
10 dB Setting		50 dB Setting	
Gain (Hi-Z)	4.75 x 10 ³ V/A ±2%	Gain (Hi-Z)	4.75 x 10 ⁵ V/A ±2%
Gain (50 Ω)	2.38 x 10 ³ V/A ±2%	Gain (50 Ω)	2.38 x 10 ⁵ V/A ±2%
Bandwidth	8.5 MHz	Bandwidth	90 kHz
Noise (RMS)	320 μV	Noise (RMS)	475 μV
NEP (@ λ _p)	1.0 x 10 ⁻¹¹ W/√Hz	NEP (@ λ _p)	1.5 x 10 ⁻¹² W/√Hz
Offset	±6 mV (Typ.) ±12 mV (Max)	Offset	±15 mV (Typ.) ±40 mV (Max)
20 dB Setting		60 dB Setting	
Gain (Hi-Z)	1.5 x 10 ⁴ V/A ±2%	Gain (Hi-Z)	1.5 x 10 ⁶ V/A ±5%
Gain (50 Ω)	0.75 x 10 ⁴ V/A ±2%	Gain (50 Ω)	0.75 x 10 ⁶ V/A ±5%
Bandwidth	1.9 MHz	Bandwidth	33 kHz
Noise (RMS)	310 μV	Noise (RMS)	850 μV
NEP (@ λ _p)	3.0 x 10 ⁻¹² W/√Hz	NEP (@ λ _p)	1.5 x 10 ⁻¹² W/√Hz
Offset	±6 mV (Typ.) ±15 mV (Max)	Offset:	±20 mV (Typ.) ±75 mV (Max)
30 dB Setting		70 dB Setting	
Gain (Hi-Z)	4.75 x 10 ⁴ V/A ±2%	Gain (Hi-Z)	4.75 x 10 ⁶ V/A ±5%
Gain (50 Ω)	2.38 x 10 ⁴ V/A ±2%	Gain (50 Ω)	2.38 x 10 ⁶ V/A ±5%
Bandwidth	775 kHz	Bandwidth	12 kHz
Noise (RMS)	300 μV	Noise (RMS)	1.5 mV
NEP (@ λ _p)	1.25 x 10 ⁻¹² W/√Hz	NEP (@ λ _p)	2.0 x 10 ⁻¹² W/√Hz
Offset	±8 mV (Typ.) ±15 mV (Max)	Offset	±20 mV (Typ.) ±200 mV (Max)

² The PDA10CS has a 50 Ω series terminator resistor (i.e. in series with amplifier output). This forms a voltage divider with any load impedance (e.g. 50 Ω load divides signal in half).

Electrical Specifications		
Detector	-	InGaAs PIN
Active Area	-	Ø1.0 mm (0.8 mm ²)
Wavelength Range	Λ	900 to 1700 nm
Peak Wavelength	λ_p	1550 nm (Typ)
Peak Response	$\mathcal{R}(\lambda_p)$	1.05 A/W (Typ)
Amplifier GBP	-	600 MHz
Output Impedance	-	50 Ω
Max Output Current	I_{OUT}	100 mA
Load Impedance	-	50 Ω to Hi-Z
Gain Adjustment Range	-	0 dB to 70 dB
Gain Steps	-	8 x 10dB Steps
Output Voltage	V_{OUT}	0 to 5 V ³ (50 Ω) 0 to 10 V ⁴ (Hi-Z)

General	
On/Off Switch	Slide
Gain Switch	8 Position Rotary
Output	BNC (DC Coupled)
Package Size	2.76" x 2.06" x 0.88" (70.1 mm x 52.3 mm x 22.4 mm)
PD Surface Depth	0.16" (4.1 mm)
Weight, Detector Only	0.15 lbs
Accessories	SM1T1 Coupler SM1RR Retainer Ring
Operating Temp	0 to 40 °C
Storage Temp	-55 to 125 °C
AC Power Supply	AC – DC Converter
Input Power ⁵	31 W 100 – 200 VAC (50 to 60Hz) 220 – 240 VAC (50 to 60 Hz)

³ If using a CW light source on 0 dB gain setting, maximum output voltage is 2.5 V.

⁴ If using a CW light source on 0 dB gain setting, maximum output voltage is 5 V.

⁵ Although the power supply is rated for 31 W the PDA10CS actual usage is <5 W over the full operating range.

6.1. Response Curve

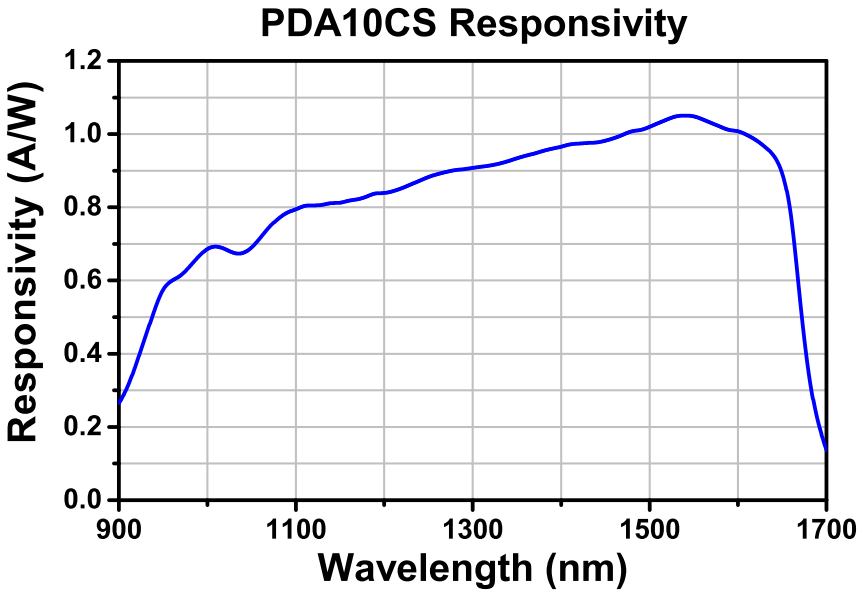

6.2. Mechanical Drawing

Visit the web for a more detailed mechanical drawing.

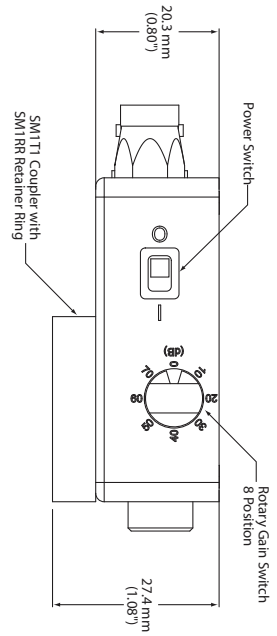
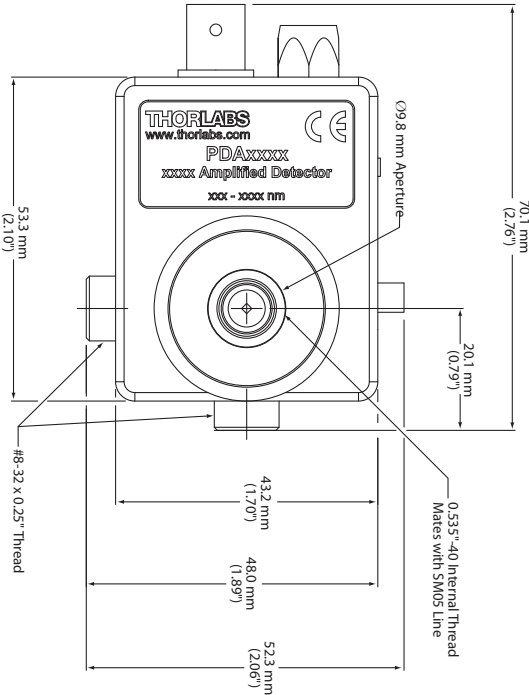
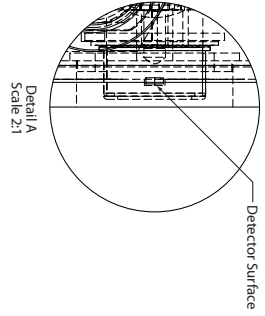
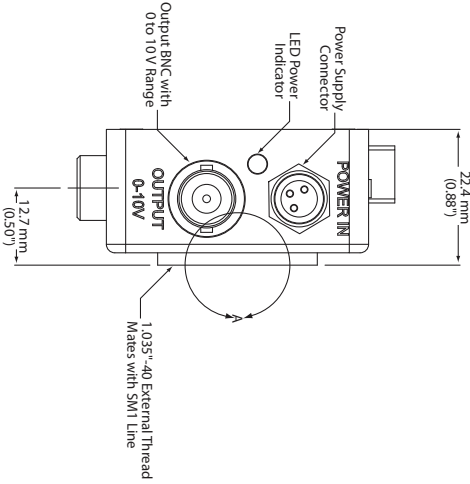

Chapter 7 Certificate of Conformance



THORLABS

www.thorlabs.com

EU Declaration of Conformity

in accordance with EN ISO 17050-1:2010

We: Thorlabs Inc.
 Of: 56 Sparta Avenue, Newton, New Jersey, 07860, USA

in accordance with the following Directive(s):

2014/35/EU	Low Voltage Directive (LVD)
2014/30/EU	Electromagnetic Compatibility (EMC) Directive
2011/65/EU	Restriction of Use of Certain Hazardous Substances (RoHS)

hereby declare that:

Model: PDA10A, PDA8A, PDF10A, PDA36A, PDA100A, PDA8A/M, PDF10A/M, PDA36A-EC, PDA10AEC, PDA100A-EC, PDA10CF, PDA10CS, PDF10C, PDA10D, PDA10CF-EC, PDA10CS-EC, PDF10C/M, PDA10D-EC, PDA50B, PDA50B-EC, PDA30G, PDA20H, PDA30G-EC, PDA20H-EC, PDA25K, PDA25K-EC, DET25K, DET25K/M, DET10A, DET35A, DET100A, DET100A/M, DET18A/M, DET36A/M, DET50B, DET50B/M, DET23C, DET23C/M, DET30B, DET30B/M, PDA30B, PDA30B-EC, DET10D, DET10D/M, PDA20C, PDA20C/M, PDA20CS, PDA20CS-EC, DET01CF, DET01CF/M, DET02AFC, DET02AFC/M, DET08CF, DET08CF-EC, DET08CF/M, DET08CL/M, DET025AFC, DET025AFC/M, DET025A, DET025A/M, DET025AFC/M, DET025A/M, DET025A/M

Equipment: *Fixed and Switchable Gain Detectors*

is in conformity with the applicable requirements of the following documents:

EN 61010-1	Safety Requirements for Electrical Equipment for Measurement, Control and Laboratory Use.	2010
EN 61326-1	Electrical Equipment for Measurement, Control and Laboratory Use - EMC Requirements	2013

and which, issued under the sole responsibility of Thorlabs, is in conformity with Directive 2011/65/EU of the European Parliament and of the Council of 8th June 2011 on the restriction of the use of certain hazardous substances in electrical and electronic equipment, for the reason stated below:

does not contain substances in excess of the maximum concentration values tolerated by weight in homogenous materials as listed in Annex II of the Directive

I hereby declare that the equipment named has been designed to comply with the relevant sections of the above referenced specifications, and complies with all applicable Essential Requirements of the Directives.

Signed: 

Name: Ann Strachan

Position: Compliance Manager

On: 13 January 2017

EDC - PDA and DET family products -2017...



Chapter 8 Regulatory

As required by the WEEE (Waste Electrical and Electronic Equipment Directive) of the European Community and the corresponding national laws, Thorlabs offers all end users in the EC the possibility to return “end of life” units without incurring disposal charges.

- This offer is valid for Thorlabs electrical and electronic equipment:
- Sold after August 13, 2005
- Marked correspondingly with the crossed out “wheelie bin” logo (see right)
- Sold to a company or institute within the EC
- Currently owned by a company or institute within the EC
- Still complete, not disassembled and not contaminated

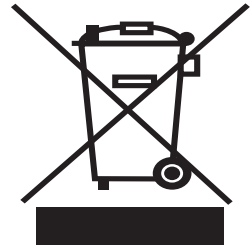

Wheelie Bin Logo

As the WEEE directive applies to self contained operational electrical and electronic products, this end of life take back service does not refer to other Thorlabs products, such as:

- Pure OEM products, that means assemblies to be built into a unit by the user (e.g. OEM laser driver cards)
- Components
- Mechanics and optics
- Left over parts of units disassembled by the user (PCB's, housings etc.).

If you wish to return a Thorlabs unit for waste recovery, please contact Thorlabs or your nearest dealer for further information.

8.1. Waste Treatment is Your Own Responsibility

If you do not return an “end of life” unit to Thorlabs, you must hand it to a company specialized in waste recovery. Do not dispose of the unit in a litter bin or at a public waste disposal site.

8.2. Ecological Background

It is well known that WEEE pollutes the environment by releasing toxic products during decomposition. The aim of the European RoHS directive is to reduce the content of toxic substances in electronic products in the future.

The intent of the WEEE directive is to enforce the recycling of WEEE. A controlled recycling of end of life products will thereby avoid negative impacts on the environment.

Chapter 9 Thorlabs Worldwide Contacts

For technical support or sales inquiries, please visit us at www.thorlabs.com/contact for our most up-to-date contact information.



USA, Canada, and South America

Thorlabs, Inc.
sales@thorlabs.com
techsupport@thorlabs.com

Europe

Thorlabs GmbH
europe@thorlabs.com

France

Thorlabs SAS
sales.fr@thorlabs.com

Japan

Thorlabs Japan, Inc.
sales@thorlabs.jp

UK and Ireland

Thorlabs Ltd.
sales.uk@thorlabs.com
techsupport.uk@thorlabs.com

Scandinavia

Thorlabs Sweden AB
scandinavia@thorlabs.com

Brazil

Thorlabs Vendas de Fotônicos Ltda.
brasil@thorlabs.com

China

Thorlabs China
chinasales@thorlabs.com



THORLABS

www.thorlabs.com
