THORLABS

**SH05 and SH05/M
Ø1/2" Beam Shutters**

Operating Manual



















Table of Contents

Chapter 1	Warning Symbol Definitions	1
Chapter 2	Safety	2
Chapter 3	Description.....	3
3.1.	<i>SH05 Beam Shutter</i>	3
3.1.1.	SH05 Shutter Overview	4
Chapter 4	Specifications	6
4.1.	<i>Drawing</i>	8
Chapter 5	Regulatory	9
Chapter 6	Thorlabs Worldwide Contacts.....	10

Chapter 1 Warning Symbol Definitions

Below is a list of warning symbols you may encounter in this manual or on your device.

Symbol	Description
	Direct Current
	Alternating Current
	Both Direct and Alternating Current
	Earth Ground Terminal
	Protective Conductor Terminal
	Frame or Chassis Terminal
	Equipotentiality
	On (Supply)
	Off (Supply)
	In Position of a Bi-Stable Push Control
	Out Position of a Bi-Stable Push Control
	Caution: Risk of Electric Shock
	Caution: Hot Surface
	Caution: Risk of Danger
	Warning: Laser Radiation
	Caution: Spinning Blades May Cause Harm

Chapter 2 Safety



WARNING



Extremely high powered lasers will create a safety hazard and cause damage to this product. The shutter for this product was tested with high power laser sources at wavelengths of 532 nm and 1064 nm. The point at which damage to the shutter surface occurred is given in the chart below. If the damage to the shutter surface occurs and bare aluminum is present, then unwanted and dangerous reflections can occur. Be aware not to exceed the given limits when focusing the beam; damage to the unit may occur at a lower power level than given in the table below when using focusing optics.

Wavelength	Damage Threshold	Spot Dia.	Exposure	Incidence Angle
532 nm	1500 W/cm ²	730 µm	10 sec/site	0°
1064 nm	20 000 W/cm ²	950 µm	10 sec/site	0°



WARNING



Safety Eyewear is recommended whenever working with laser beams. While working with laser beams in conjunction with this shutter, dangerous situations can occur if the shutter is open while the laser beam is on. It is recommended that the shutter remain close while making adjustments to a laser set up and the proper eyewear should always be worn while operating lasers.



WARNING



This product operates at a sound level near or slightly above 70 dB. During operation at 25 Hz the sound level was measured to be 71 dB at a distance of 1 meter.



ATTENTION



Caution is given when there is a possibility of damage to the product. This product was not assessed to ISO 61508 which is a Safety Equipment Standard.

Chapter 3 Description

3.1. SH05 Beam Shutter

The SH05 is a rotary, electro-mechanical actuator to provide sub-millisecond shutter operation. In general operation, the shutter remains in a closed position and then opens with a pulse control signal. As long as the control voltage to the shutter remains high, the shutter will stay open; however, if the voltage suddenly decreases, the shutter will close, providing inherent "fail-safe" operation. An optical sensor, which detects the shutter blade's position within the housing, confirms the state of the shutter position, making it ideal in applications where a laser safety lockout is required. The rate at which the device is opened can be controlled. The unit has a 0.50-inch aperture opening and is compatible with the Thorlabs SM05 mounting system.

The input aperture of the SH05 is threaded with Thorlabs' SM05 (0.535"-40) thread to interface easily with all of our SM05 lens tubes. The SH05 comes with 8-32 tapped holes for mounting to our imperial Ø1/2" posts. The SH05/M comes with M4 tapped holes for mounting to our metric Ø1/2" posts. All shutters come with a 10' cable to connect the shutter directly to the SC10 Controller (sold separately).

3.1.1. SH05 Shutter Overview

The SH05 shutter contains a rotary solenoid presenting a large inductive load to the controlling device. As this inductor is charged, the resulting movement of the actuator takes a finite amount of time (opening of the shutter). Conversely when the voltage is removed from the shutter it takes a finite time for the inductor to discharge and for the mechanics to release the actuator (close the shutter). The shutter timing varies and is dependent on the duration and magnitude of the driving pulse and the magnitude of the sustaining hold voltage.

The SC10 provides a 5 millisecond 24 V driving voltage to actuate the shutter and a holding voltage of 10 Volts. The timing for the SH05 is characterized below when operated with the SC10 controller.

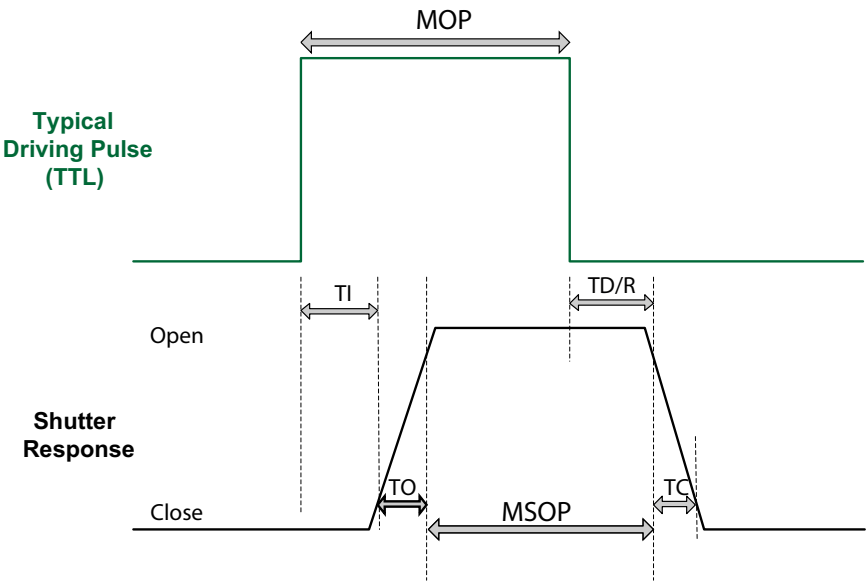

Figure 1 SH05 Timing Driven by Thorlabs SC10 Shutter Controller

Timing Performance

Event	TIME (ms Typical)
TI	8.0
TO	3.0
TD/R	13.0
TC	4.08
MSOP*	27.0
MOP (SC10)	10

TI, Transfer Initialize: Time from the application of an energizing voltage to the initial movement of the shutter.

TO, Transfer Open: Time for the shutter to move from 20% exposed to the 80% exposed. This is measured across the 0.5" travel distance of the shutter.

TD/R, Transfer Dwell/Release: Time from the removal of the holding voltage or pulse to the point where the shutter begins to close.

TC, Transfer Close: Time for shutter to close from an 80% exposure to 20% exposure.

MSOP*, Minimum Shutter Open Time: Minimum shutter open time using the MOP from the SC10 controller.

MOP, Minimum Open Pulse: Minimum pulse width of SC10 controller.

Note: The shutter SH05 is not meant for operation in critical timing applications. Performance may vary from unit to unit.

Typical Performance

The SH05 is capable of operating at a sustained maximum rate of 25 Hz with a minimum on time of 10 ms. As programmed exposure times (open times) increase to beyond 20 ms the dominant characteristics of magnetic distortion, TI, and TD/R, as shown in Fig. 1, become constants. The net effect of this anomaly is that the delay from the control pulse (or trigger) to the shutter opening is 5 ms, and the duty cycle distortion incurred is ±5 ms. As an example: If the SC10 is programmed for 100 ms open and 100 ms close time, the result would be a 105 ms exposure and a 95 ms closure on the SH05.

Chapter 4 Specifications

Thorlabs recommends that the SH05 shutter only be controlled by the use of the Thorlabs SC10 Shutter Controller or the Thorlabs KSC101 K-Cube Solenoid Controller.

Interface Connector

The interface connector on the SH05 is a 6-pin HRS female connector (HR10A-7R-6SB(73)). The pin descriptions are as follows:

Pin	Description
1	Monitor Opto Anode
2	Solenoid
3	Solenoid
4	Monitor Opto Cathode
5	Monitor Opto Emitter
6	Monitor Opto Collector

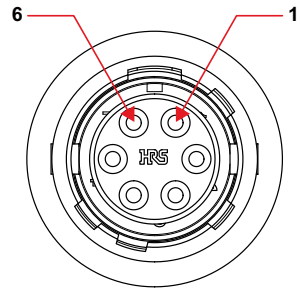
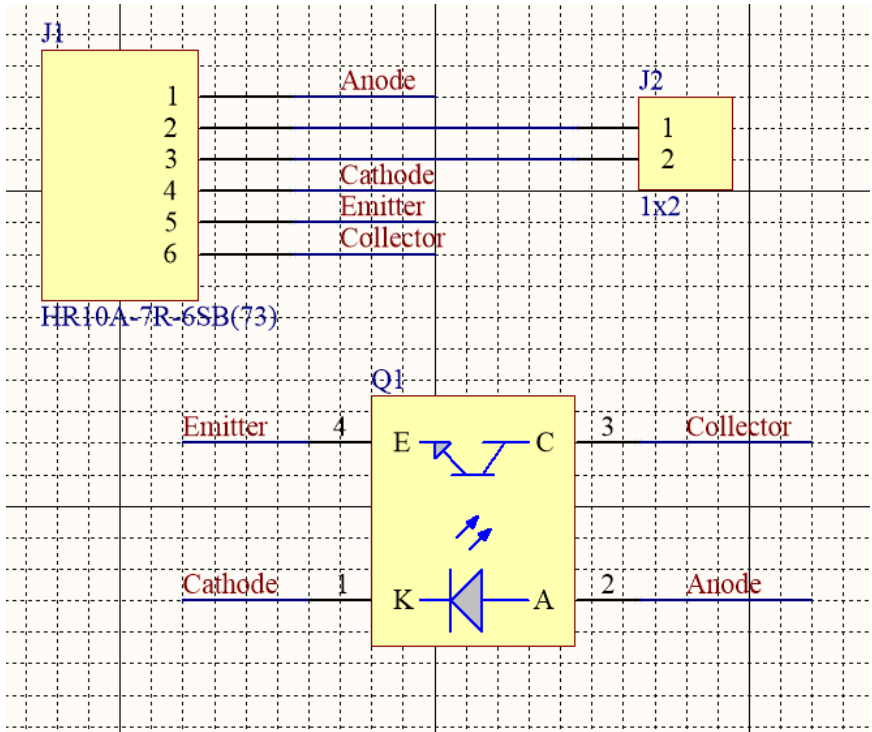

Figure 2 SH05 Connector



A schematic snippet to show the pin assignments: Typically pins 4 and 5 (cathode and emitter) are tied to circuit ground. The anode is the anode connection of an IR LED. This is tied to a voltage source (V_{supply}) thru a current set resistor. Current could be set to 10 mA (0.01 A), then the forward voltage for the LED is around 1.2 V. So to set the LED current the resistor value would be $(V_{supply} - 1.2 V) / 0.01 A$. The LED should be on always when the shutter is in operation.

The Collector pin is the output signal and needs a pullup resistor to an appropriate logic supply, typically 3.3 V or 5 V. Do not use more than 5 V.

4.1. Drawing

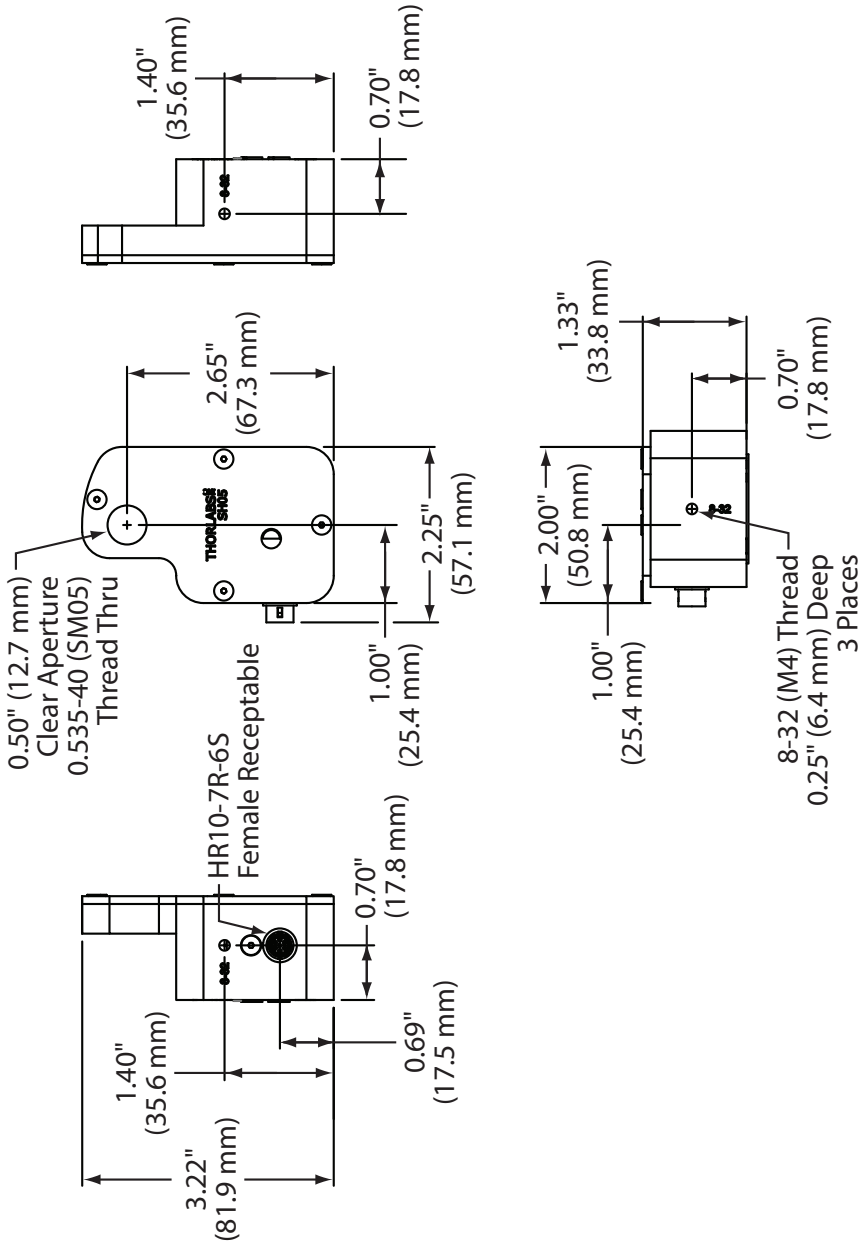

Chapter 5 Regulatory

As required by the WEEE (Waste Electrical and Electronic Equipment Directive) of the European Community and the corresponding national laws, Thorlabs offers all end users in the EC the possibility to return “end of life” units without incurring disposal charges.

- This offer is valid for Thorlabs electrical and electronic equipment:
- Sold after August 13, 2005
- Marked correspondingly with the crossed out “wheelie bin” logo (see right)
- Sold to a company or institute within the EC
- Currently owned by a company or institute within the EC
- Still complete, not disassembled and not contaminated

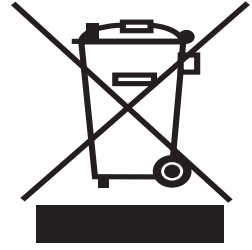

Wheelie Bin Logo

As the WEEE directive applies to self-contained operational electrical and electronic products, this end of life take back service does not refer to other Thorlabs products, such as:

- Pure OEM products, that means assemblies to be built into a unit by the user (e.g. OEM laser driver cards)
- Components
- Mechanics and optics
- Left over parts of units disassembled by the user (PCB's, housings etc.).

If you wish to return a Thorlabs unit for waste recovery, please contact Thorlabs or your nearest dealer for further information.

Waste Treatment is Your Own Responsibility

If you do not return an “end of life” unit to Thorlabs, you must hand it to a company specialized in waste recovery. Do not dispose of the unit in a litter bin or at a public waste disposal site.

Ecological Background

It is well known that WEEE pollutes the environment by releasing toxic products during decomposition. The aim of the European RoHS directive is to reduce the content of toxic substances in electronic products in the future.

The intent of the WEEE directive is to enforce the recycling of WEEE. A controlled recycling of end of life products will thereby avoid negative impacts on the environment.

Chapter 6 Thorlabs Worldwide Contacts

For technical support or sales inquiries, please visit us at www.thorlabs.com/contact for our most up-to-date contact information.



USA, Canada, and South America

Thorlabs, Inc.
sales@thorlabs.com
techsupport@thorlabs.com

Europe

Thorlabs GmbH
europe@thorlabs.com

France

Thorlabs SAS
sales.fr@thorlabs.com

Japan

Thorlabs Japan, Inc.
sales@thorlabs.jp

UK and Ireland

Thorlabs Ltd.
sales.uk@thorlabs.com
techsupport.uk@thorlabs.com

Scandinavia

Thorlabs Sweden AB
scandinavia@thorlabs.com

Brazil

Thorlabs Vendas de Fotônicos Ltda.
brasil@thorlabs.com

China

Thorlabs China
chinasales@thorlabs.com



THORLABS

www.thorlabs.com
